



Industrial Monochrome CCD Camera

CV-A50 IR

Operation Manual

Revision 0

Manual: Version- 1.0



DECLARATION OF CONFORMITY
AS DEFINED BY THE COUNCIL DIRECTIVE
89/336/EEC
EMC (ELECTROMAGNETIC COMPABILITY)
WE HEREWITH DECLARE THAT THIS PRODUCT
COMPLIES WITH THE FOLOWING PROVISIONS APPLYING TO IT.
EN 61000-6-2
EN 61000-6-3

Table of Contents

1. General.....	2
2. Standard Composition	2
3. Main Features	2
4. Camera Housing and Dimensions.....	3
5. Pin Assignment.....	4
5.1. 12-pin Multi-connector (DC-IN/VIDEO OUT, EXT.HD/VD IN)	4
5.2. 6-pin Multi-connector (TRIGGER and RS232C)	4
5.3. Input and Output Circuits.....	5
5.3.1. Video output.....	5
5.3.2. Trigger input.....	5
5.3.3. HD and VD input.....	5
5.3.4. HD, VD, PCLK, WEN and EEN output	5
6. Functions and Operations	6
6.1. Basic functions	6
6.2. Input-output of HD/VD Signals.....	7
6.3. Continuous Operation (Non triggered).....	7
6.4. External Trigger Modes.....	11
6.5. Edge Pre-select Mode	12
6.6. Pulse Width Control Mode	13
6.7. Frame-delay read out Mode	14
6.8. Long Time Exposure Mode	15
6.9. Start/Stop Mode.....	16
6.10. Other Functions.....	17
7. Configuring the Camera	18
7.1. RS-232C control.	18
7.2. CV-A50 IR RS-232C command list.....	19
7.3. Camera Control Tool for CV-A50/60	20
7.4.1 HD/VD input-output selection	21
7.4.2. Selecting termination of HD/VD input signals.....	21
8. Specifications	22
9. Spectral Sensitivity.....	23
10. Appendix	23
10.1. CV-A50 IR emulating CV-M50 IR interfacing	23
10.2. WEN out on pin 6 on 6 pin connector	24
10.3. CV-A50 IR without sync on video output.....	24
10.4. Precautions	25
10.5. Typical CCD Characteristics.....	25
11. Users Record.....	26

1. General

The CV-A50 IR is a monochrome CCIR and EIA interlaced 1/2" CCD cameras with enhanced near IR response, designed for a wide range of automated imaging application. The camera features a compact housing and a wide range of unique functions.

The asynchronous trigger can be set to work in several modes, to allow functions such as pulse width controlled shutter, programmable shutter speed and long time integration.

All mode settings of the camera can be set up via an RS-232C interface, greatly reducing the need for mechanical switches or jumpers.

The CV-A50 IR outputs an analogue video signal, with composite sync.

The latest version of this manual can be downloaded from: www.jai.com

The latest version of Camera Control Tool for CV-A50IR (CV-A50/60) can be downloaded from: www.jai.com

2. Standard Composition

The standard camera composition consists of the camera main body and C-mount protection cap.

3. Main Features

- Compact size 1/2" monochrome near IR CCD camera
- 752 (h) x 582 (v) pixels for CCIR, 768 (h) x 494 (v) for EIA
- Improved sensitivity, dynamic range and smear performance
- High S/N ratio > 59dB
- Extended range of functions and options compared to CV-M50 IR
- Interlaced or non-interlaced scanning. Field or frame accumulation.
- Internal, external HD/VD or random synchronization
- Edge pre-select, pulse width and start/stop trigger modes
- Long time exposure with external VD pulse
- Frame delay readout mode
- Exposure enable EEN, write enable WEN and pixel clock out
- No mechanical switches or jumpers for mode setting
- Short ASCII commands for modes setting via serial port
- Shutter speed down to 1/10,000 in 8 steps
- Windows NT/2000/XP setup software

4. Camera Housing and Dimensions

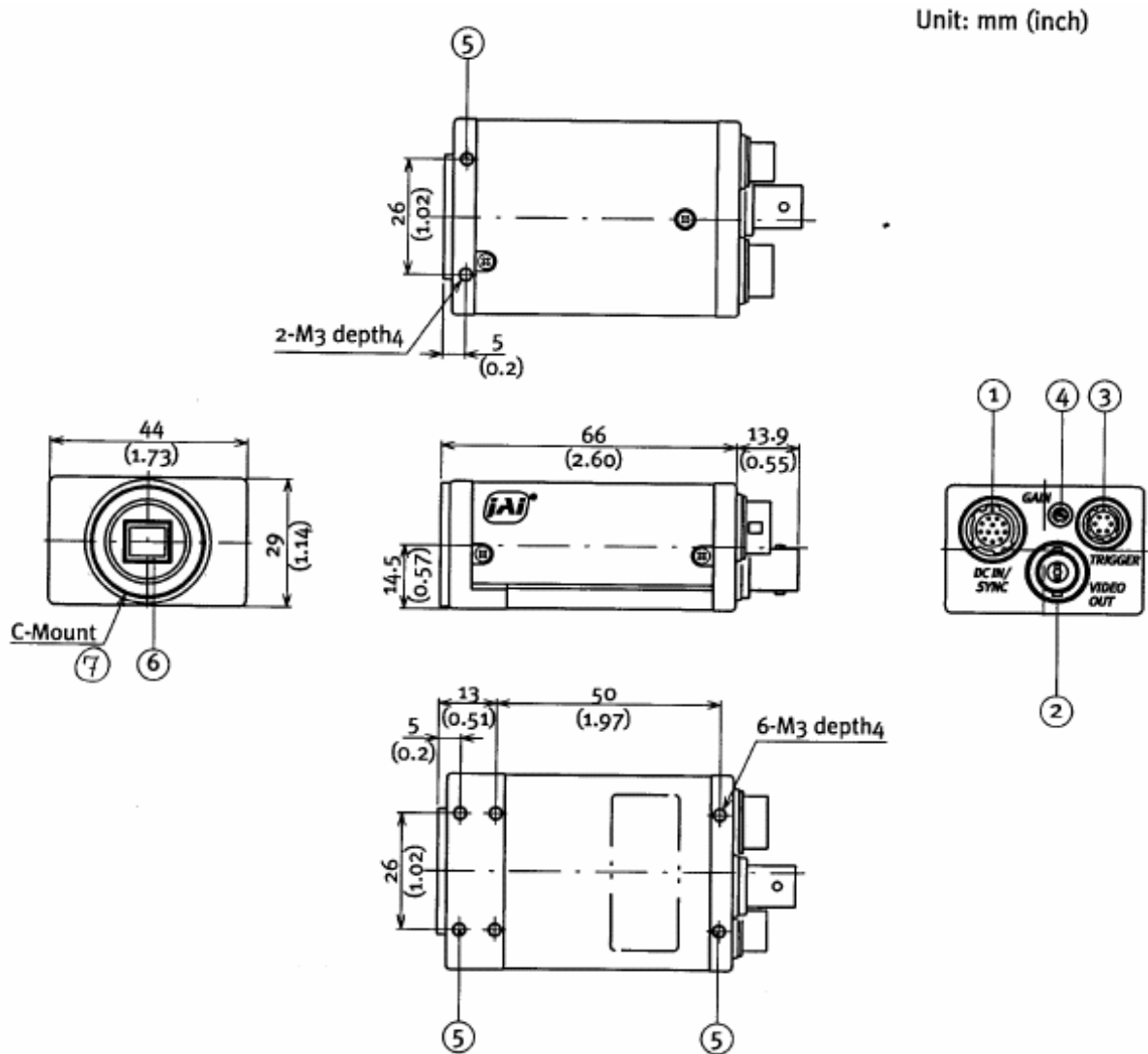

Fig. 1. Locations and dimensions.

1. 12-pin Hirose connector for frame grabber interfacing and power (12V DC).
2. BNC connector for video output. VS 1.0 Vpp 75 Ohm.
3. 6-pin Hirose connector for trigger input and RS-232C control interface.
4. Gain potentiometer for manual gain setting.
5. Mounting holes, 8 x M3. For precision mounting use only the 4 holes located at the forward part of the bottom plate.
6. 1/2" interline-transfer type CCD sensor.
7. Lens mount for C-mount lenses. *1)

Note *1): Rear protrusion on the C-mount lens must be less than 10mm (0.4 inches approx.).
When IR-cut filter is used, it must be less than 7.0 mm (0.28 inches approx.).

The IR-cut filter is placed in the C-mount thread.
The C-mount IR-cut filter must be ordered separately.

5. Pin Assignment

5.1. 12-pin Multi-connector (DC-IN/VIDEO OUT, EXT.HD/VD IN)

Type: HR10A-10R-12PB-01 (Hirose) male

Seen from rear.

Pin configuration is compatible with EIAJ standard

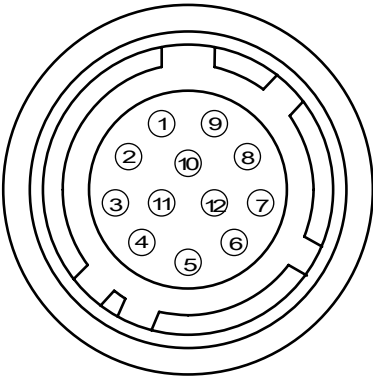

Pin no.	Signal	Remarks
1	GND	
2	+12 V DC input	
3	GND	
4	Video output	Parallel with the BNC connector.
5	GND	
6	<i>HD input/HD output</i>	*) SW2.1 on for 75Ω. SW1.1 on for HD out.
7	<i>VD input/VD output</i>	*) SW2.2 on for 75Ω. SW1.2 on for VD out.
8	GND	
9	Pixel clock output	*) JP2 short and PC=1 for pclk out.
10	<i>WEN output</i>	*) *2) GND if JP5 open and JP3 short
11	<i>Trigger input</i>	*) +12V DC if JP1 short and JP4 open
12	GND	

Fig. 2. 12-pin connector.

Plugs for cable: HR10A-10P-12S

5.2. 6-pin Multi-connector (TRIGGER and RS232C)

Type: HR10A-7R-6PB (Hirose) male

Seen from rear.

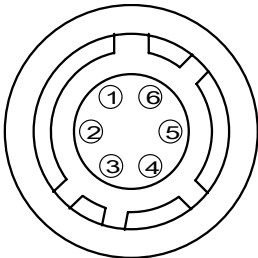

Pin no.	Signal	Remarks
1	TXD out	RS-232C
2	RXD in	RS-232C
3	GND	
4	GND	
5	<i>Trigger input</i>	*) Parallel with pin 11 on 12 pin con
6	<i>EEN output</i>	*) *3) WEN out refer to chapter 10.2.

Fig. 3. 6-pin connector.

Plugs for cable: HR10A-7P-6S

Notes:

- *) Alternative signals can be placed on these pins by switch or jumper settings or RS-232C commands. Refer to chapter 10.1. and 10.2. for alternative signals. Configurations shown in *Bold + italic* is factory setting.
- *2) WEN (Write Enable) pulse indicates the period of effective video signal output. It is useful for setting the timing with framegrabber.
- *3) EEN (Exposure Enable) pulse indicates the duration of the shutter, and can be used for controlling strobe illumination. EEN will be low all the time in normal continuous mode (TR=0), if the selected exposure time is longer than the video readout time.

For schematic diagram of the input and output circuit with alternative settings refer to 5.3.

5.3. Input and Output Circuits

In the following schematic diagrams the input and output circuits for video and timing signals are shown. Jumper settings are shown as for factory default. For alternative connections refer to “10.1. CV-A50 IR emulating CV-M50 IR interfacing.”

5.3.1. Video output

The video output is a 75 Ω DC coupled circuit. The BNC connector and pin #4 on the 12-pin connector is in parallel. Avoid double termination. The video DC level is shown with 75 Ω termination.

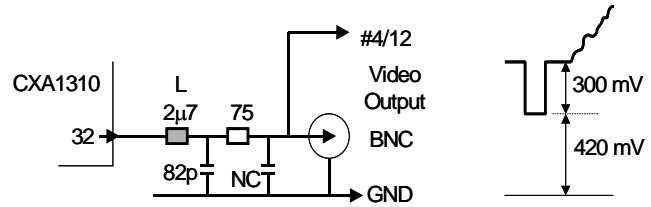

Fig. 4. Video output.

5.3.2. Trigger input

The trigger input is AC coupled. To allow a long pulse width, the input circuit is a flip flop, which is toggled by the negative or positive differentiated spikes caused by the falling or rising trigger edges. The trigger polarity can be changed. Trigger input level 4 V ±2 V. The trigger-input impedance is 1 kΩ. JP1 and JP4 are for alternative configuration for pin #10.

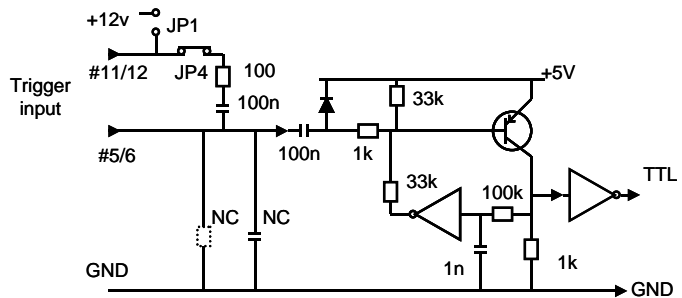

Fig. 5. Trigger input.

5.3.3. HD and VD input

The input circuit for external HD and VD signals are shown. It can be 75 Ω terminated by closing SW2. SW1 will switch to output the internal HD and VD signal. HD and VD input level is 4 V ±2 V.

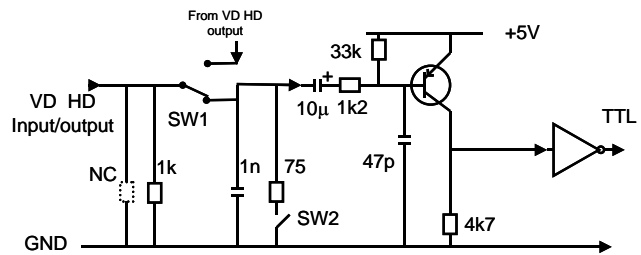

Fig. 6. HD and VD input.

5.3.4. HD, VD, PCLK, WEN and EEN output

Output circuit for these signals are 75 Ω complementary emitter followers. It will deliver a full TTL signal. JP5 and JP3 are for alternative configuration for pin #10. Output level ≥4 V from 75Ω. (No termination). The WEN polarity can be changed.

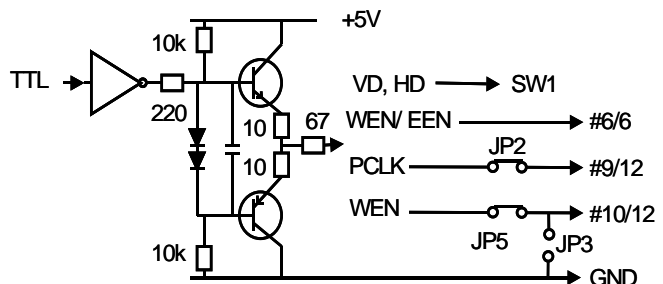

Fig. 7. HD, VD, PCLK, WEN and EEN output.

6. Functions and Operations

Apart from the standard continuous operation, the CV-A50 IR features three external asynchronous trigger modes (edge pre-select, pulse width controlled and start/stop) and a special frame-delay readout mode. Long integration time mode is also supported.

6.1. Basic functions

Some of the primary camera functions need a general introduction before the operation modes are described. The list below shows the primary functions from the command list.

SM	Shutter Mode	Normal shutter, Programmable Exposure
SH	Shutter Speed	Off to 1/10,000 second
PE	Programmable Exposure	1.5 H to 1023.5 H
SC	Scanning Format	Interlaced, non-interlaced, (1/2 partial, 1/3 partial)
TR	Trigger Mode	Normal, Edge, PWC, frame delay readout
FR	Accumulation	Long time exposure, start-stop
		Field, Frame

The shutter *SM* can be set to normal (*SM*=0), where the exposure time is selected from 8 fixed step with the command *SH*, or programmable exposure (*SM*=1). Here the command *PE* allows up to 1023 steps with 1 period resolution (64 μ s) for edge pre-select mode. For normal modes *PE* can be up to 312 for CCIR and 262 for EIA.

The scanning format *SC* can be selected between interlaced and non-interlaced sync signals. Further it is possible to select 1/2 and 1/3 partial scanning. It is not supported for the camera.

The accumulation *FR* can be field or frame. Fig. 9. shows details for frame and field accumulation with shutter OFF, (left), and shutter on, (right).

The accumulation in all trigger modes is H synchronous. The exposure will start at the first HD pulse after the trigger falling edge. Fig. 8. shows the details. In all triggered shutter modes, the shortest shutter time is limited to ≥ 1.5 H or 1/10,000. In trigger modes, the exposure time is not limited to the readout time. It can be longer.

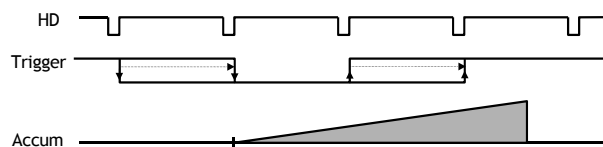

Fig. 8. PWC H synchronous accumulation.

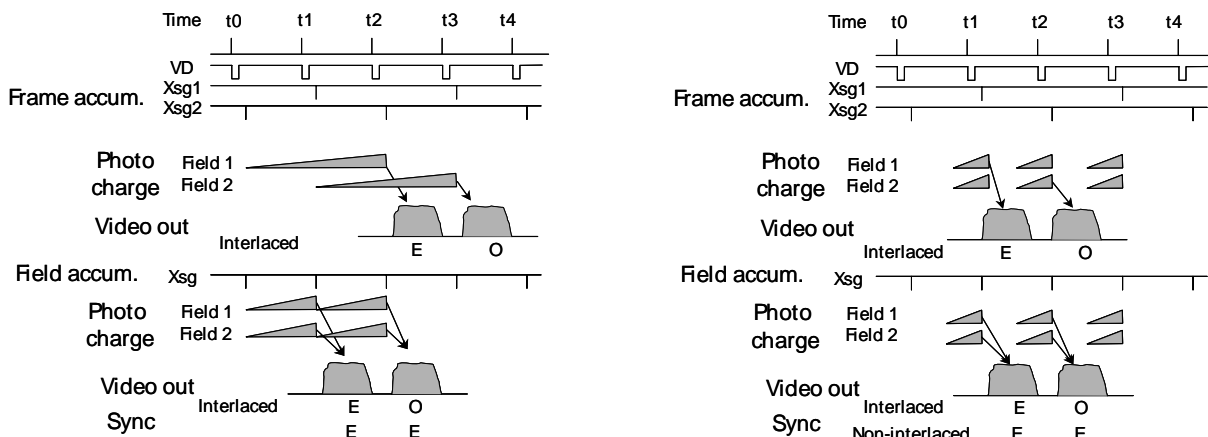

Fig. 9. Frame and field accumulation without shutter (left) and with shutter (right).

6.2. Input-output of HD/VD Signals

In the default setting the camera will accept external HD/VD signals on pin 6 and 7 of the 12 pin Hirose connector. If external HD/VD is applied, the camera will synchronize to it. If no external sync signals are applied, the camera will operate with its internal x-tal controlled sync.

The time requirements to the relation between VD and HD are shown in fig. 16.

The input is TTL level as factory setting. It can be 75 Ohm terminated by the internal switch on the PK8277 board. SW2-1 for HD and SW2-2 for VD. On for 75 Ohm termination.

To output the internal HD/VD signals on pin 6 and 7 the internal switch SW1-1 and 1-2 on the PK8277 board should be set ON. The output is TTL level from a 75-Ohm source.

Refer to “7.4. Internal Switch and Jumper settings.”

In trigger modes the internal VD will be reset and restarted after the triggered exposure. It will continuous until next trigger.

To use this mode:

Set function: SW 1 on PK8277 to IN for external VD/HD input. *Factory default.*
 SW 2 on PK8277 to 75 Ω for termination of VD/HD.
 SW 2 on PK8277 to TTL for TTL level for VD/HD. *Factory defaults.*
 SW 1 on PK8277 to OUT for internal VD/HD output.

Input: Ext. VD in or int. VD out on pin 7 on 12-pin connector.
 Ext. HD in or int. HD out on pin 6 on 12-pin connector.

Important notes on using this mode

External sync system should follow the camera scanning system.

6.3. Continuous Operation (Non triggered)

For applications that do not require asynchronous external trigger (continuous operation). This is the factory default setting of the camera.

To use this mode:

Set function: Trigger mode to “Normal” TR=0
 Shutter mode “Normal” or “Programmable” SM=0, SM=1
 “Shutter Speed” SH=0 through 7
 “Programmable exposure” for CCIR PE=1 through 312
 “Programmable exposure” for EIA PE=1 through 262
 Polarity and other functions

Input: Ext. VD on pin 7 on 12-pin connector. If used.
 Ext. HD on pin 6 on 12-pin connector. If used.

Important notes on using this mode

Fig. 10 through fig.13A on the following pages shows horizontal and vertical timing details for CCIR and EIA interlaced and non-interlaced.

CV-A50/A60 CCIR Horizontal Timing Chart

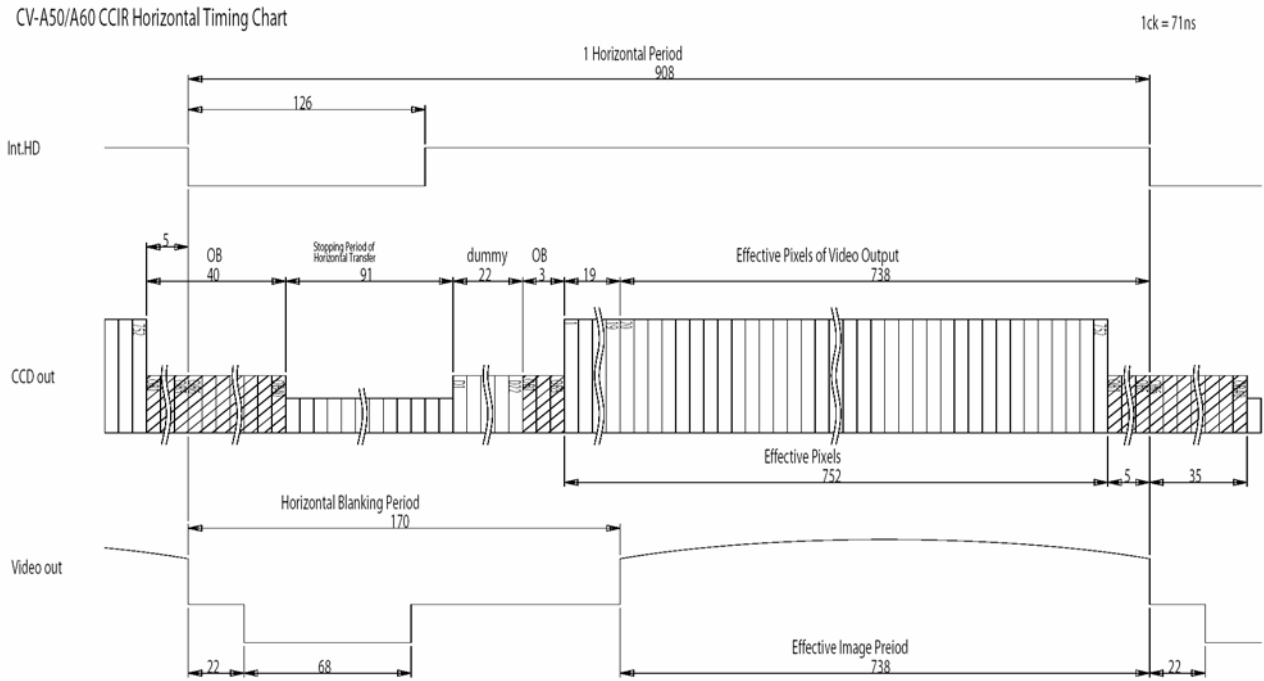

Fig. 10. Horizontal timing details and pixel numbering for the CCD array. CCIR

CV-A50/A60 EIA Horizontal Timing Chart

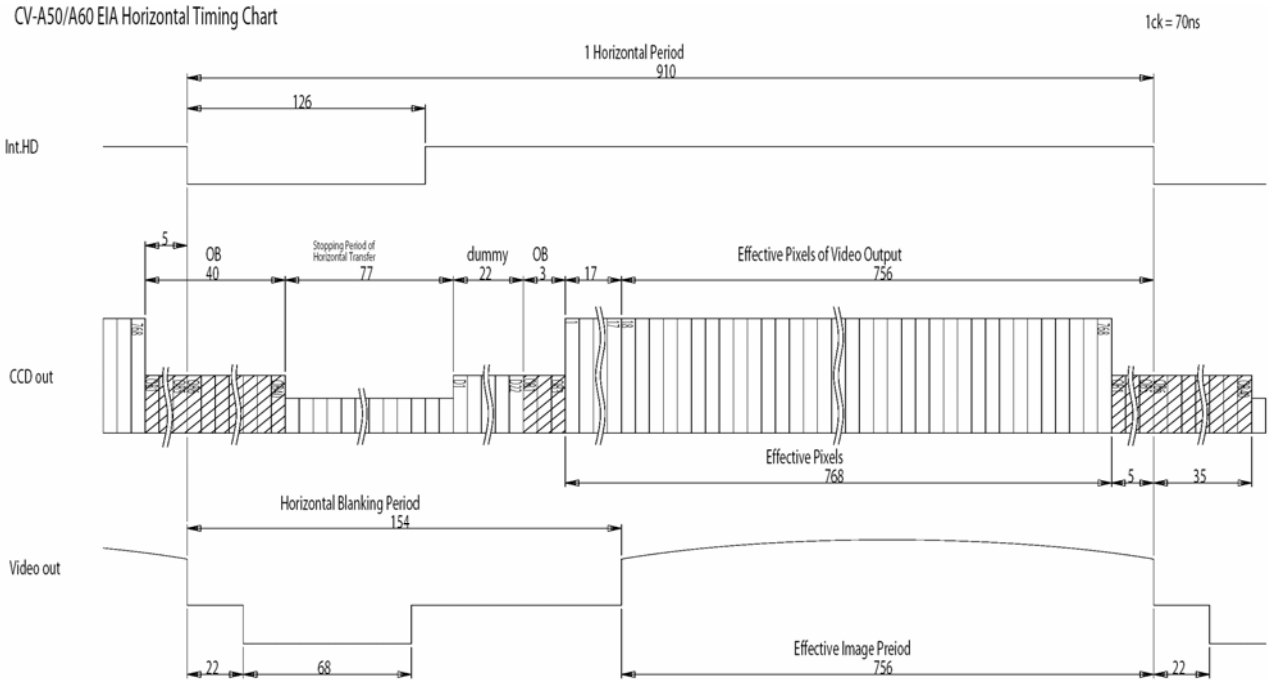

Fig. 11. Horizontal timing details and pixel numbering for the CCD array. EIA

CV-A50/A60 CCIR 2:1 Interlace Vertical Timing Chart

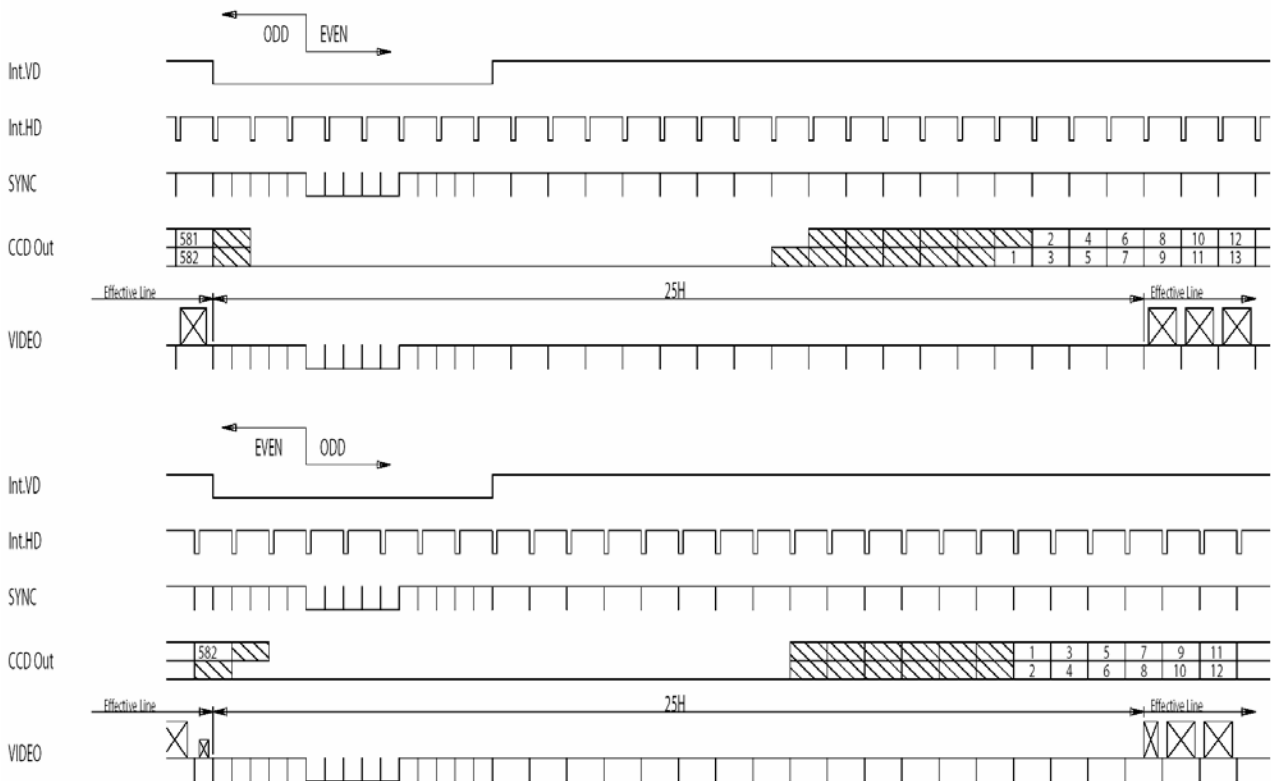

Fig. 12. Vertical timing details for interlaced. CCIR

CV-A50/A60 EIA Non-Interlace Vertical Timing Chart

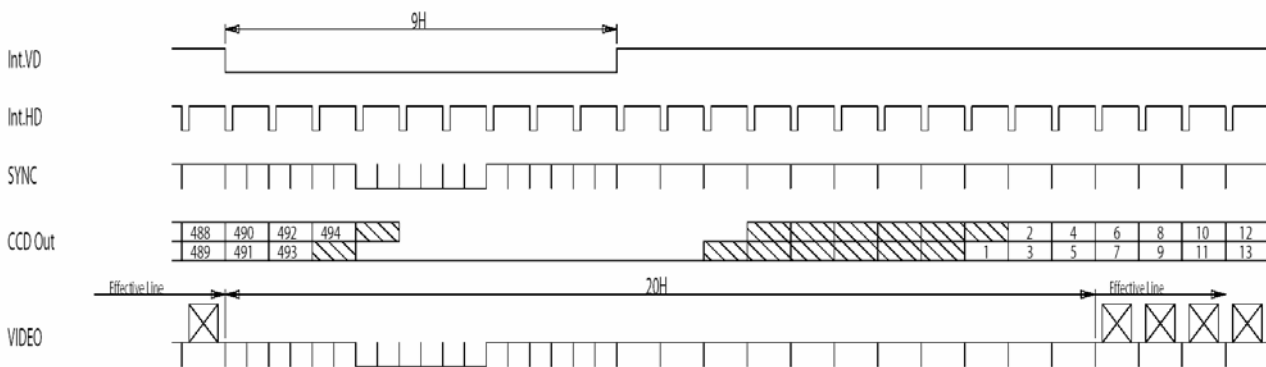

Fig. 12A. Vertical timing details for non-interlaced. CCIR

CV-A50/A60 EIA 2:1 Interlace Vertical Timing Chart

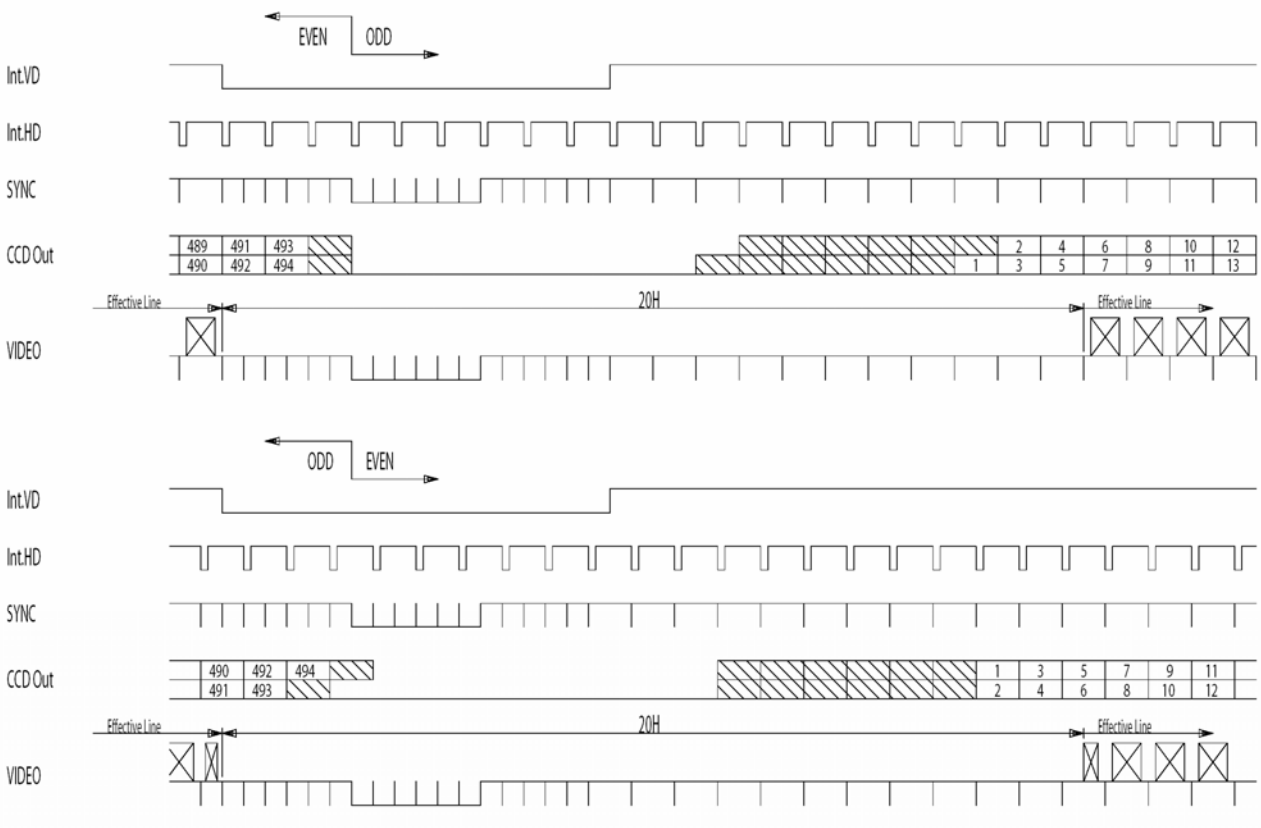

Fig. 13. Vertical timing details for interlaced. EIA

CV-A50/A60 CCIR Non-Interlace Vertical Timing Chart

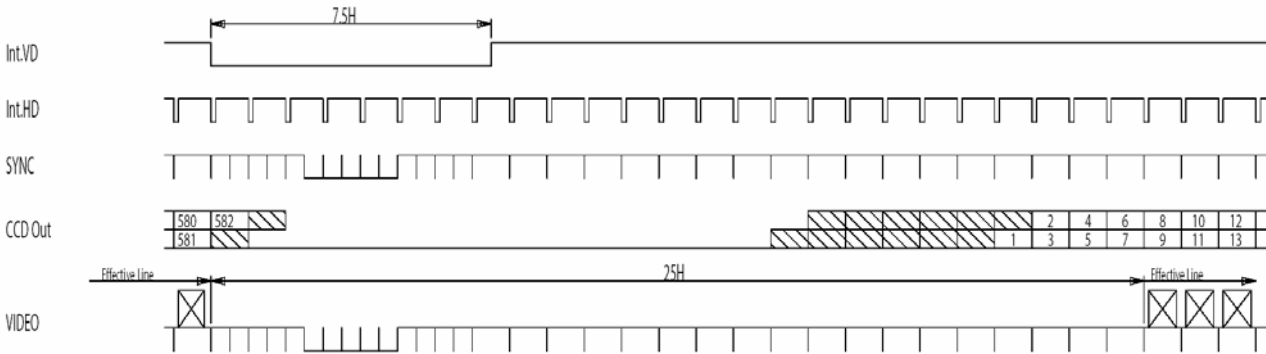

Fig. 13A. Vertical timing details for non-interlaced. EIA

6.4. External Trigger Modes

This camera has 5 external asynchronous trigger modes, which can be set by RS-232C commands.

- | | |
|-------------------------------------------|-----------------------------------------------|
| 1. <i>Edge Pre-select Mode. TR=1</i> | Pre-selected exposure. (SM=0, SM=1) |
| 2. <i>Pulse Width Control Mode. TR=2</i> | Pulse width controlled exposure. |
| 3. <i>Frame Delay read out mode. TR=3</i> | PWC exposure read out by ext. VD. |
| 4. <i>Long Time Exposure Mode. TR=4</i> | Exposure is interval between ext. VD. |
| 5. <i>Start/stop Mode. TR=5</i> | Exposure start by trigger and stop by ext. VD |

An external trigger pulse initiates the capture (input on pin 11 of the 12-pin Hirose connector or pin 5 of the 6-pin Hirose). The leading edge of the trigger pulse initiates the exposure (this is a falling edge if factory default) and the duration of the pulse governs the exposure (accumulation) time. If the polarity of this pulse is reversed, the camera can be configured to correct for it.

The duration of the external trigger pulse must be greater than 1H. It is recommended to make this longer, typically 9H.

Important notes on using trigger modes:

The accumulation is HD synchronously accumulation. The accumulation starts at the first HD after the trigger leading edge. Shown in fig. 15. To avoid the <1H jitter caused by this delay, synchronize the external trigger to HD as shown in fig. 14. The trigger level translations should be placed inside the time A, which is 8 μseconds.

Do not input a new trigger before the previous video is read out. (WEN is high).

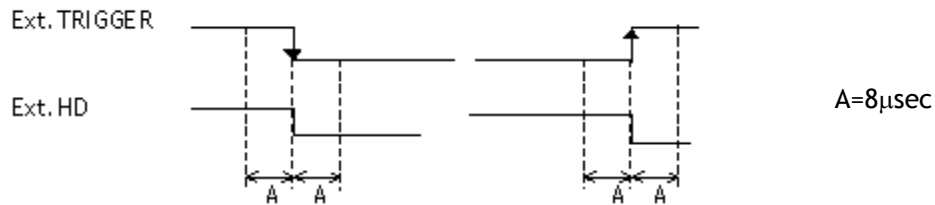

Fig. 14. Trigger/HD timing.

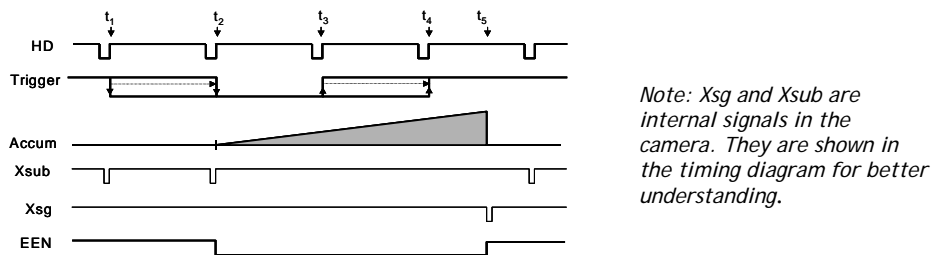

Fig. 15. Pulse Width H synchronous accumulation.

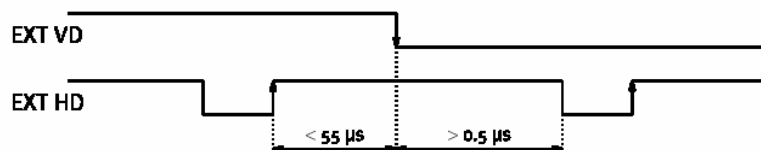

Fig. 16. Ext. HD and ext. VD phase conditions.

6.5. Edge Pre-select Mode

The leading edge of the trigger pulse initiates the exposure. The exposure time (accumulation time) is governed by the pre-defined shutter speed set by RS-232C.

The resulting video is output as “odd field” for EIA and “even field” for CCIR, and appear 9H (EIA) or 10H (CCIR) after the leading edge of WEN (polarity is user selectable).

To use this mode:

Set function:	Trigger mode to “Edge Pre-select”	TR=1
	Accumulation to “Field”	FR=0
	Scanning to “Non-interlaced”	SC=1
	Shutter mode to “Normal” or “Programmable”	SM=0, SM=1
	Shutter Speed	SH=0 through 7
	or Programmable exposure	PE=1 through 1023
	Polarity for trigger and other functions	
Input:	Ext. trigger to pin 5 on 6 pin connector (or pin 11 on 12-pin connector).	
	Ext. HD to pin 6 on 12-pin connector. (If used).	

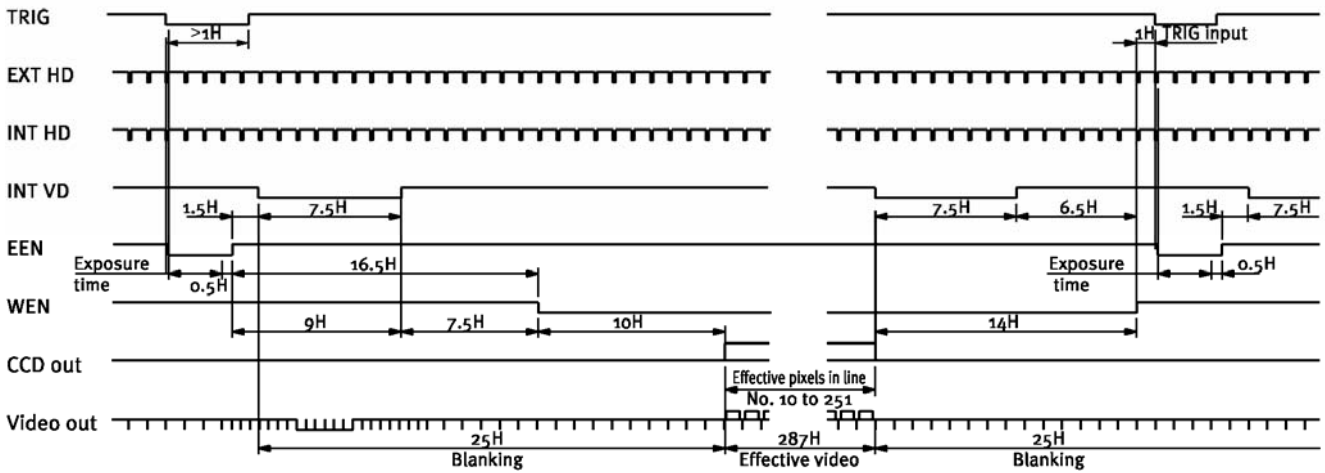

Fig. 17. Edge pre-select CCIR

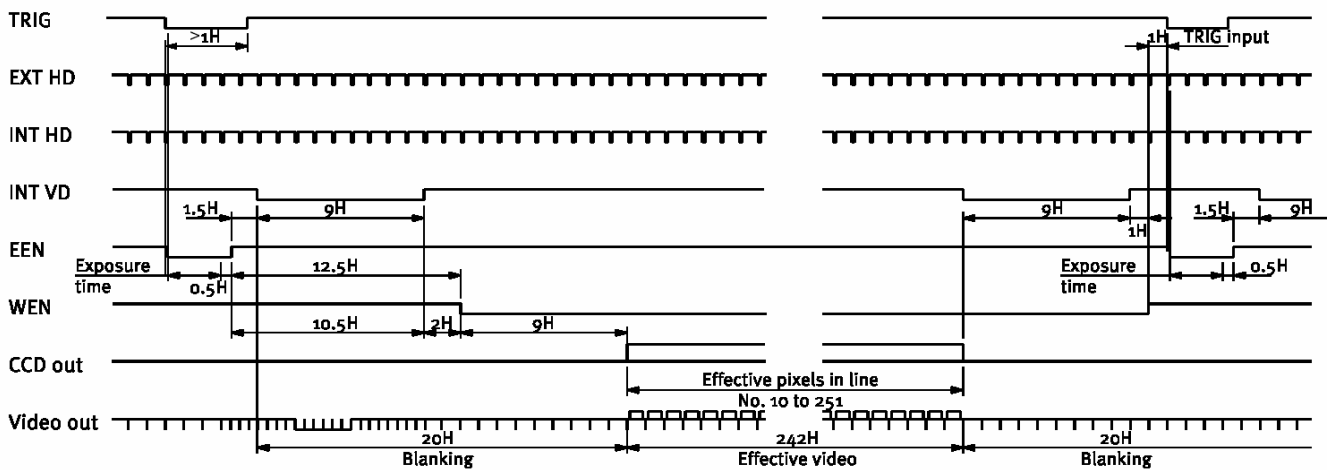

Fig. 18. Edge pre-select EIA

Important notes on using this mode:

- The duration of the external trigger pulse must be greater than 1H. It is recommended to make this longer, typically 9H.
- Do not input external VD signal at Pin No. 7 of the 12-pin Hirose connector, as it may disturb the external trigger function.

6.8. Long Time Exposure Mode

The exposure time is the interval between 2 ext. VD pulses sent to the VD input of the camera (Pin No. 7 of the 12-pin Hirose connector). The exposure starts after input of the first ext. VD pulse, and ends after the next input of the next ext. VD pulse, which again starts a new exposure. The long time exposure is a continuous process where each external VD will synchronize the camera, stop on exposure, start a new exposure and read out the previous accumulated signal. The exposure time can be selected in intervals of complete vertical timing periods (525H for EIA and 625H for CCIR).

To use this mode:

Set function:	Trigger mode to "Long time exposure"	TR=4
	Accumulation to "Field" or "Frame"	FR=0, F=1
	Scanning to "Interlaced"	SC=0
	Shutter to "OFF"	SH=0
	Polarity and other functions	
Input:	Ext. VD to pin 7 on 12 pin connector.	
	Ext HD to pin 6 on 12 pin connector.	

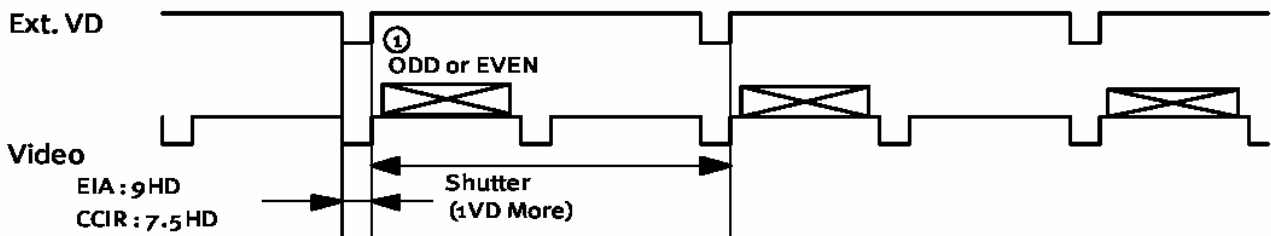

Fig. 23. Long time exposure. Field accumulation.

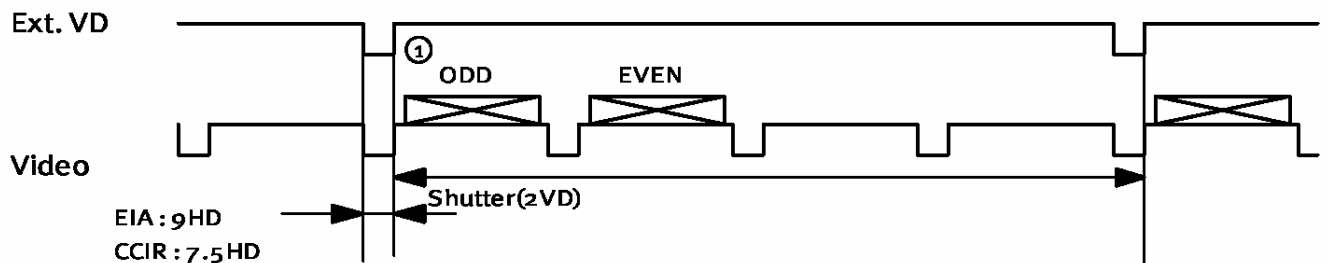

Fig. 24. Long time exposure. Frame accumulation.

Important notes on using this mode:

- Exposure time range is 1/30 sec. to ∞. However, it is recommended not to use exposure over 2.0 sec. This is because visible dark current noise may appear on the video signal due to the long time exposure of the CCD image sensor.
- Ext. HD signal (TTL 2.0-5.0V) has to be input continuously.
- See Fig. 16 for the phase relationship between ext. HD and ext. VD pulses
- The EEN pulse is not provided when using this mode.

Important notes on using this mode:

- As the start of exposure will be synchronized with the internal H signal, the start of exposure may be shifted by max 1H.
- To avoid this shift (jitter), synchronize the camera with an external HD and make sure that the trigger pulse aligns to the HD signal as shown in Fig. 14.
- For exposures <14 H, the trigger pulse is after the extern VD pulse. Fig. 26

6.10. Other Functions

Gain and analogue settings.

!! Do not adjust these settings unless you have knowledge of video adjustments !!

AS, AGC Switch

The video gain can be set to AGC or manual.

In AGC mode the video level is kept constant by the automatic gain control circuit within a 12 dB range. Normal 700 mVpp \pm 30 mV. The level can be adjusted with AG, AGC level in the range 0 to 255.

RP, Rear Potentiometer

In manual gain mode, the gain level can be adjusted by the rear potentiometer, or it can be adjusted by GA, Manual Gain level in the range 0 to 255.

SU, Setup level. This setting can adjust the setup level (or black level). Normal 20 mVpp \pm 2 mv.

WC, White clip level. To adjusting the wanted white clip level. Normal 800 mVpp \pm 30 mv.

GA, Gamma select.

Gamma can be 1 (linear) or 0.45.

Signal and Polarity.

PC, Pixel clock on/off.

Set to on if the pixel clock is used. Note that jumper JP2 on rear board PK8274 should be closed. (factory setting). Refer to chapter 10.2. for position. To avoid interference the pixel clock out should be off when the pixel clock is not used.

TP, Trigger polarity.

Will invert the trigger-input signal.

WP, WEN polarity.

Will invert the WEN output signal.

7. Configuring the Camera

7.1. RS-232C control.

All configuration of the A50/60 camera is done via the RS-232C port. The camera can be set up from a PC running terminal emulator software, or using JAI's camera control software. Below is the description of the ASCII based short command protocol.

Communication setting.

Baud Rate	9600 bps
Data Length	8 bit
Start Bit	1 bit
Stop Bit	1 bit
Parity	None
Xon/Xoff Control	None

RS 232C cable

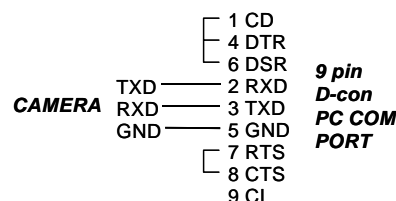

Fig. 27. RS-232C cable.

Protocol.

Transmit setting to camera:

NN=[Parameter]<CR><LF> (NN is any kind of command. Capital or small letters.)

To have all communication visible on the emulator screen, start with:

EB=1<CR><LF>

The camera answers:

COMPLETE<CR><LF>

Transmit the following to see the current parameter for a command:

NN?<CR><LF> (NN is any commands with parameters.)

The camera answers: NN=[Parameter]

Transmit the following to see the camera current settings:

ST?<CR><LF>

The camera returns the current parameter settings, firmware and camera type and number.

Transmit the following to get command list help:

HP?<CR><LF>

The camera returns a complete command list.

Unknown commands send to camera: (XY is unknown command).

XY=1<CR><LF>

The camera answers: 01 Unknown Command!!<CR><LF>

Invalid parameters send to camera: (99 is invalid parameter for SH).

SH=99<CR><LF>

The camera answers: 02 Bad Parameters!!<CR><LF>

7.2. CV-A50 IR RS-232C command list.

	Command Name	Format	Parameter		Remarks
A - General settings and useful commands					
EB	Echo Back	EB=[Param.]<CR><LF>	0=Echo off	1=Echo on	Off at power up
ST	Camera Status request	ST?<CR><LF>			Actual setting
HP	Online Help request	HP?<CR><LF>			Command list
VN	Firmware version	VN?<CR><LF>			3 letter version
B - Timing and shutter related commands					
SC	Scanning format	SC=[Param.]<CR><LF>	0=Interlaced 2=1/2 partial	1=Non-interl. 3=1/3 partial	Partial scanning is not supported
TR	Trigger mode	TR=[Param.]<CR><LF>	0=normal 2=Pulse width 4=Long time	1=Edge 3=Frame delay 5=Start/stop	
SM	Shutter mode	SM=[Param.]<CR><LF>	0=Normal	1=Programmab.	
SH	Shutter speed	SH=[Param.]<CR><LF>	0=Off 0=1/50 (1/60) 2=1/250 4=1/1000 6=1/4000	1=1/100 1=1/125 3=1/500 5=1/2000 7=1/10000	Continuous only Trigger modes and Continuous
PE	Programmable expos.	PE=[Param.]<CR><LF>	0= No function 1023=1023.5H	1=1.5H	CCIR. H=64µsec EIA, H=63.5µsec *1)
C - Signals and polarity					
FR	Accumulation	FR=[Param.]<CR><LF>	0=Field	1=Frame	
PC	Pixel clock	PC=[Param.]<CR><LF>	0=no clock out	1=clock out	Should be off when not used
TP	Trigger polarity	TP=[Param.]<CR><LF>	0= active low	1= active high	*2)
WP	WEN polarity	WP=[Param.]<CR><LF>	0= active low	1= active high	
D - Gain and analogue signals setting					
AS	AGC Switch	AS=[Param.]<CR><LF>	0=AGC off	1=AGC on	0= manual gain
AG	AGC Level	AG=[Param.]<CR><LF>	0=low	255=high	Range 0 to 255
GA	Manual gain Level	GA=[Param.]<CR><LF>	0=low	255=high	Range 0 to 255
RP	Rear Potentiometer	RP=[Param.]<CR><LF>	0>manual gain	1=rear potm.	
SU	Setup Level	SU=[Param.]<CR><LF>	0=low	255=high	Range 0 to 255
WC	White clip Level	WC=[Param.]<CR><LF>	0=low	255=high	Range 0 to 255
GS	Gamma Select	GS=[Param.]<CR><LF>	0=gamma 1	1=gamma 0.45	
E - Saving and loading data in EEPROM					
LD	Load settings from camera EEPROM	LD=[Param.]<CR><LF>	0=Factory data 2=User 2 area	1=User 1 area 3=User 3 area	Latest used data area becomes default at next power up
SA	Save settings to camera EEPROM	SA=[Param.]<CR><LF>	1=User 1 area 3=User 3 area	2=User 2 area	
EA	EEPROM area request	EA?<CR><LF>			Return latest used area

*1) In normal non trigger mode (TR=0) PE<312 for CCIR and PE<262 for EIA. In trigger mode TR=1, EEN will not be correct if PE>833.

*2) If positive logic is used (TP=1), the first trigger pulse after power up will be ignored.

!! Do not try to use commands not shown in the list.

7.3. Camera Control Tool for CV-A50 IR (CV-A50/60 software)

From www.jai.com CV-A50/60 Camera Control Tool for Windows 98/NT/2000 can be downloaded.

The control tool contents a camera control program and tools for making your own program. Below the different windows are shown.

Control bar



Windows for all functions

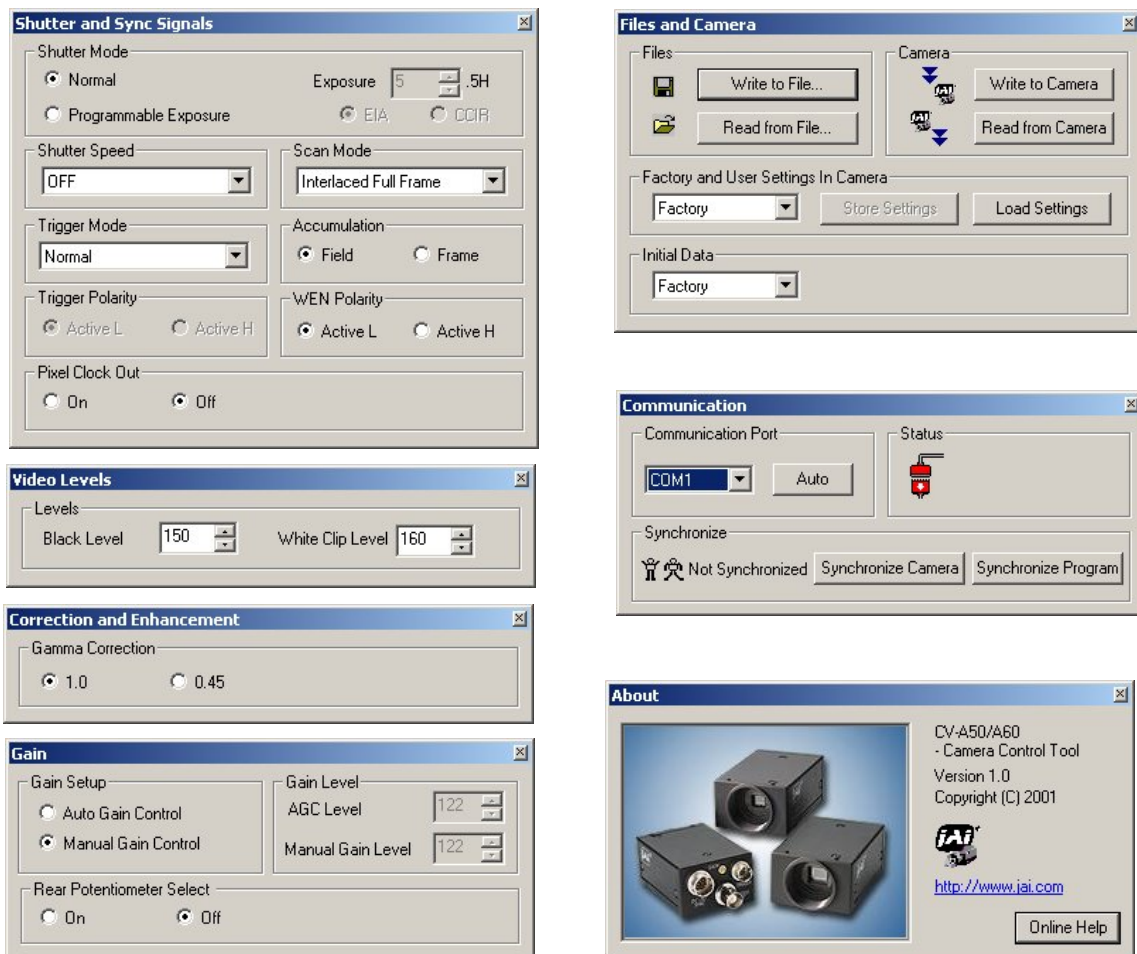

Fig. 28. Windows from Camera Tools.

For the integrator and experienced user, the Camera Control Toll is much more than a program with a window interface. It also provides an easy and efficient ActiveX interface built for MS Windows 98, ME, NT and 2000. The OCX interface has the ability to connect to the camera using the serial interface of the PC by reading and writing properties for the camera. This integration requires simple programming skills within Visual Basic, Visual C++ or similar languages in a Microsoft Windows environment.

7.4. Internal Switch and Jumper Settings.

7.4.1 HD/VD input-output selection

In the default setting the camera will accept external HD/VD signals on pins 6 and 7 of the 12 pin Hirose connector. The composite video signal from the camera will be synchronized to an external HD/VD source connected to the camera. TTL level (between 2 and 5 V).

To set up the camera to output HD/VD signals on pins 6 and 7 on the Hirose connector follow these steps. See fig. 29.

1. Switch off the power to the camera.
2. Remove the camera cover, by removing the 5 screws.
3. Locate switches SW1-1 and SW1-2 on the PK8277 circuit board, and set both in the ON position.

Note: The HD/VD output source is 75 Ohm.

7.4.2. Selecting termination of HD/VD input signals

The default setting of the HD/VD input is high impedance TTL. The camera expects to get a signal that swings between 2 and 5 volts. This setting allows the largest number of camera to be synchronized from a single HD/VD source (such as another camera or a frame grabber). Under certain circumstances it may be necessary to terminate the HD/VD input, in order to match the impedance of the signal source, to eliminate over/undershoot or standing waves in the signal.

To change the HD/VD input to 75Ohm terminated, follow these steps

1. Switch off the power to the camera.
2. Remove the camera cover, by removing the 6 screws.
3. Locate switches SW2-1 and SW2-2 on the PK8277 circuit board, and set the according both in the ON position.

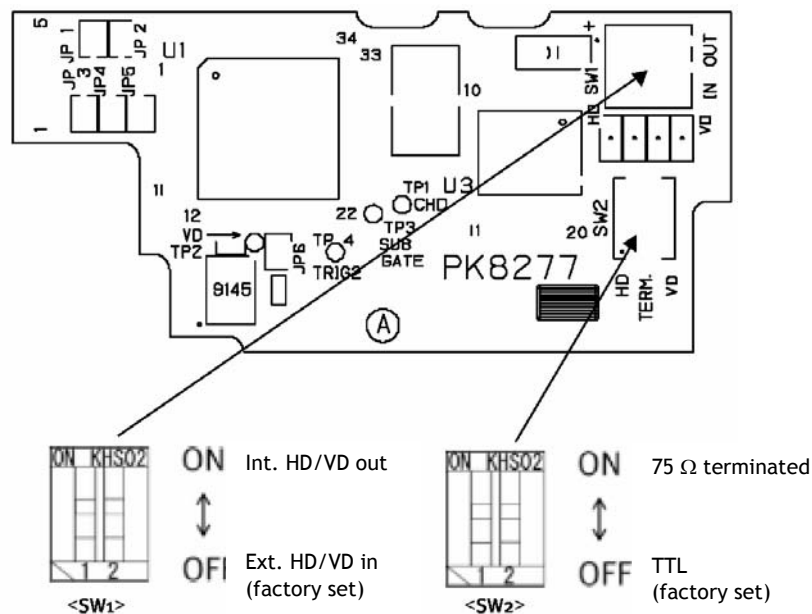

Fig. 29. HD/VD switch positions on PK8277 board.

CV-A50 IR

8. Specifications

Specifications	CV-A50 IR C	CV-A50 IR E
Scanning system	CCIR, 25 frames/sec. 625 lines, 2:1 Interlaced	EIA. 30 frames/sec. 525 lines, 2:1 Interlaced
Frame rate (Full frame)	50 Hz	59.94 Hz
Line frequency	15.625 kHz	15.734 kHz
Pixel frequency	14.1875 MHz	14.3182 MHz
CCD sensor 1/2". CV-A50	Monochr. IT CCD. ICX-429ALL	Monochr. IT CCD. ICX428ALL
Sensing area	6.4 (h) x 4.8 (v) mm	
Effective pixels	752 (h) x 582 (v)	768 (h) x 494 (v)
Pixels in video output	737 (h) x 575 (v)	758 (h) x 486 (v)
Cell size 1/2". CV-A50	8.6 (h) x 8.3 (v) μ m	8.4 (h) x 9.8 (v) μ m
Resolution horizontal	570 TV lines	
Sensitivity on sensor	0.02 Lux, Max gain, 50% video	
S/N ratio	59 dB	60 dB
Video output	Composite VS signal, 1.0 Vpp, 75 Ω	
Gamma	1.0 - 0.45	
Gain	Manual - Automatic	
Gain range	0 to +15 dB	
Accumulation	Field - Frame	
Synchronization	Int. X-tal. Ext HD/VD or random trigger	
Scanning	2:1 interlaced, non-interlaced partial scan 1/2, partial scan 1/3	
HD sync. input/output	4 Vpp \pm 2 V, 75 Ω	
Trigger input	4 Vpp \pm 2 V, 75 Ω	
WEN output (write enable)	4 Vpp \pm 2 V, 75 Ω	
EEN output (exposure enable)	4 Vpp \pm 2 V, 75 Ω	
Pixel clock output	4 Vpp \pm 2 V, 75 Ω	
Shutter	(off), 1/100, 1/250, 1/500, 1/1000, 1/2000, 1/4500, 1/10,000 sec.	
Pulse width control	1.5 H to 1000 H	
Start/stop	1/77 to 1/10,000 second	
Long time exposure	1 field to ∞	
Programmable exposure	1.5 H to 1023.5 H. In edge pre-select CCIR 1.5 to 312.5 H (EIA 1.5 to 262,5 H) Normal continuous mode	
Frame delay readout	Time from PWC trigger input to ext. VD input	
Functions controlled by RS 232C	Scanning format, Trigger mode, Shutter speed, Trigger/WEN polarity, Accumulation, Shutter mode, Programmable exposure, AGC level, White clip, Setup, Manual gain, AGC/manual gain, Internal/ potentiometer gain set, Gamma, Pixel clock, Commands and internal adjustments.	
Functions controlled by internal DIP switches	VD input/output, HD input/output HD, VD and Trigger 75 Ω termination on/off	
Operating temperature	-5°C to +45°C.	
Humidity	20 - 80% non-condensing	
Storage temp./humidity	-25°C to 60°C./20% - 90 %	
Regulations	CE (EN61000-6-2 and EN61000-6-3), FCC, RoHS, WEEE	
Power	12V DC \pm 10%. 1.5 W	
Lens mount	C-mount	
Dimensions	29 x 44 x 66 mm (HxWxD)	
Weight	150 g	

9. Spectral Sensitivity

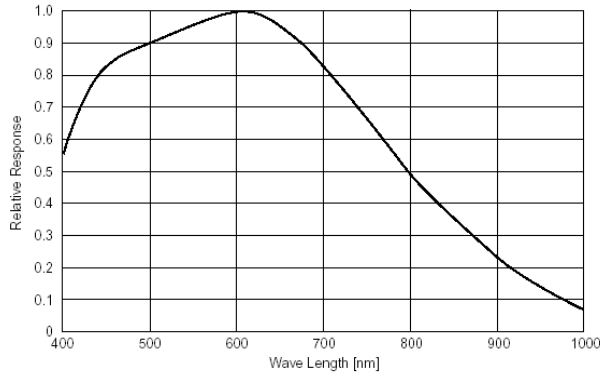

Fig. 30. Spectral sensitivity.

10. Appendix

10.1. CV-A50 IR emulating CV-M50 IR interfacing

The CV-A50 IR has a slightly different pin configuration on the 12-pin Hirose connector, compared to the CV-M50 IR. This new configuration is compliant to the EIA-J standard. This means, however, that the CV-A50 IR is not completely backward compatible with the CV-M50 IR, in all cases (depending on the cable configuration).

This application note gives detailed instruction on how to change the pin configuration, by changing internal solder jumpers.

Please note: Only a qualified electronics technician or engineer should make these changes.

Hirose pin #	Function	JP2	JP3	JP5	JP1	JP4	Remarks
9	<i>PCLK output</i> enabled	<i>Short</i>					Note 2
9	No connection	Open					
10	<i>WEN output</i>		<i>Open</i>	<i>Short</i>			
10	Connected to ground		Short	Open			
11	<i>Ext Trigger input</i>				<i>Open</i>	<i>Short</i>	
11	+12V DC in				Short	Open	

Note : Configuration shown in ***Bold+Italic*** is factory default setting

Note 2: The RS-232C command “PC” must be set to CLK

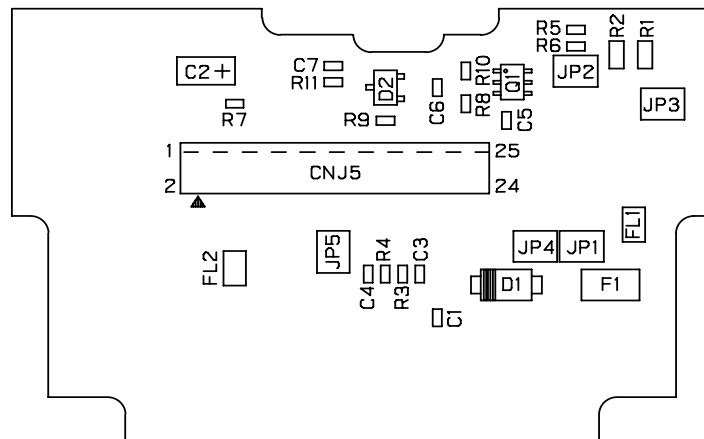

Fig. 31. PK8279 Rear Board of CV-A50/60

10.2. WEN out on pin 6 on 6 pin connector

Instead of EEN output on pin #6 on the 6 pin Hirose connector, WEN can be output by jumper settings. The 2 jumpers are found on the main board PK8275B, if the bottom plate is removed.

Signal on pin #6	JP1	JP2	Remark
<i>EEN out</i>	<i>open</i>	<i>short</i>	default
WEN out	short	open	

Configuration shown in ***Bold+Italic*** is factory default setting

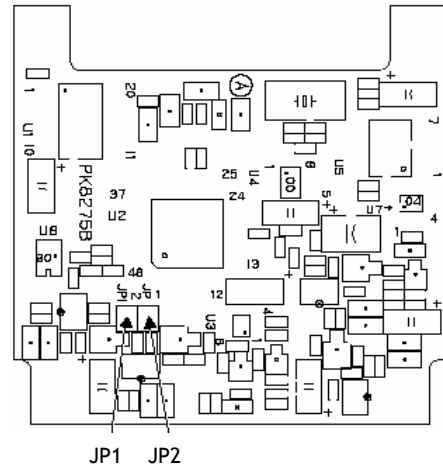

Fig. 32. PK8275B main board

10.3. CV-A50 IR without sync on video output.

For applications where the video output signal should be without the composite sync signal, it is possible to remove the sync signal by removing an internal resistor.

Remove the top cover and the bracket for holding boards. The resistor is found on the main board. (Mother board). The resistor, which is very small, can then carefully be removed with a small solder iron.

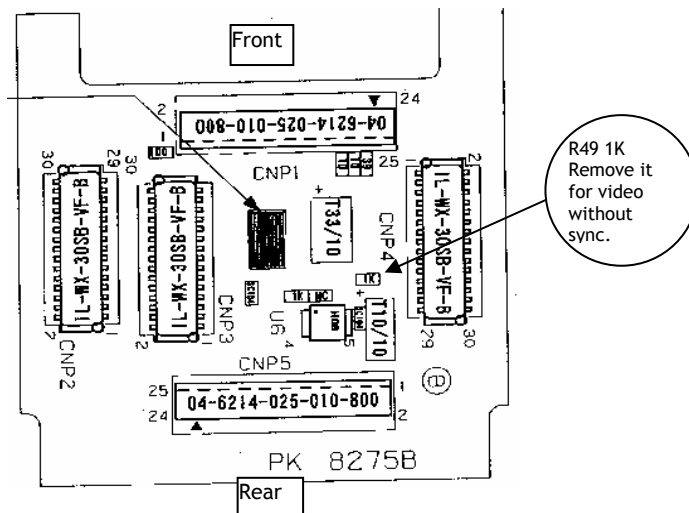

Fig. 33. PK8275B main board top side

10.4. Precautions

Personnel not trained in dealing with similar electronic devices should not service this camera. The camera contains components sensitive to electrostatic discharge. The handling of these devices should follow the requirements of electrostatic sensitive components.

Do not attempt to disassemble this camera.

Do not expose this camera to rain or moisture.

Do not face this camera towards the sun, extreme bright light or light reflecting objects.

When this camera is not in use, put the supplied lens cap on the lens mount.

Handle this camera with the maximum care.

Operate this camera only from the type of power source indicated on the camera.

Power off the camera during any modification such as changes of jumper and switch setting.

10.5. Typical CCD Characteristics

The following effects may be observed on the video monitor screen. They do not indicate any fault of the CCD camera, but do associate with typical CCD characteristics.

V. Smear

Due to an excessive bright object such as electric lighting, sun or strong reflection, vertical smear may be visible on the video monitor screen. This phenomenon is related to the characteristics of the Interline Transfer System employed in the CCD.

V. Aliasing

When the CCD camera captures stripes, straight lines or similar sharp patterns, jagged image on the monitor may appear.

Blemishes

Some pixel defects can occur, but this does not have an effect on the practical operation.

Patterned Noise

When the CCD camera captures a dark object at high temperature or is used for long time integration, fixed pattern noise (shown as white dots) may appear on the video monitor screen.

11. Users Record

Camera type: CV-A50 IR CCIR/EIA

Revision: CV-A50 IR revision 0

Serial No.

For camera revision history, please contact your local JAI distributor.

Users Mode Settings:

Users Modifications:

Company and product names mentioned in this manual are trademarks or registered trademarks of their respective owners. JAI A-S cannot be held responsible for any technical or typographical errors and reserves the right to make changes to products and documentation without prior notification.

Europe, Middle East & Africa
Phone +45 4457 8888
Fax +45 4491 8880

Asia-Pacific
Phone +81 45 440 0154
Fax +81 45 440 0166

Americas
Phone (Toll-Free) +1 877 445 5444
Phone +1 408 747 0300



See the possibilities

www.jai.com
