

❖ **TM-676oCL/TMC-676oCL** Progressive Scan CCD



- *High-speed 1/2" progressive scan IT CCD imager (KAI-0330)*
- *648(H) x 484(V) @ 60 fps*
- *9.0 μ m square pixels*
- *Compact 44 x 44 x 63 mm housing with high-rel connector*
- *LVDS versions: order TM-676o and TMC-676o*
- *Digital output and analog output*
- *60/30 frames per second selectable*
- *Full frame integration, two-row binning (648 x 242 pixels) at 120 fps*
- *Partial scan (200 lines, 120 fps)*
- *Full-frame shutter to 1/32,000 sec.*
- *Asynchronous reset, no-delay shutter*
- *Maximum dynamic range control with built-in look-up table*
- *Read-out-inhibit control for multiple-camera applications*
- *RS-232 external control*
- *Monochrome or color*



Specifications for TM-6760CL/TMC-6760CL

Specifications		TM-6760CL/TMC-6760CL
Sensor		1/2" progressive scan interline transfer CCD
Active area		5.83mm x 4.36mm
Active pixels		648 (H) x 484 (V)
Cell size		9.0 μm x 9.0 μm
Readout mode		648 (H) x 484 (V) @ 60/30 Hz (VGA output) 648 (H) x 200 (V) @ 120 Hz (partial scan) 648 (H) x 242 (V) @ 120 Hz (2-row binning)
Synchronization		Internal/External auto switch HD/VD, 4.0 Vp-p impedance 4.7K Ω VD=60/30 Hz ± 2%, non-interlace HD=31.48/15.74 kHz ± 2%
Pixel clock		25.00/12.5 MHz
S/N ratio		>50 dB
Sensitivity	Mono Color	0.88 lux f=1.4 (no shutter) @ 60 fps, 7.0 lux f=1.4 (no shutter) @ 60 fps, Pixel sensitivity: 11.5 μV/e-
Video output	Analog Digital	1.0 Vp-p, 75 Ω Camera Link (base configuration)
Color (RMC/TMC-6760 only)		Raw Bayer output for host-based interpolation
Gamma		Programmable LUT (1.0 std)
Lens mount		C-mount (use 1/2" format lenses)
Power		12V DC ± 10%, 390 mA (typical at 25° C)
Operating temperature		-10° C to 50° C
Vibration		7 Grms (10 Hz to 2000 Hz) Random
Shock		70 G, 11 ms, half-sine
Dimensions (H x W x L)		44.5 mm x 44.5 mm x 63 mm
Weight		133 g (without tripod)

GUI Interface

A user-friendly GUI (graphical user interface) is provided. This interface allows users to control the following functions of the TM-6760CL camera:

- Shutter control for manual async. and pulse-width control
- Gain control
- Offset control
- Save settings
- Load settings
- Report settings
- LUT setting and graphic display
- Scanning mode selection and option selections
- Channel auto balancing

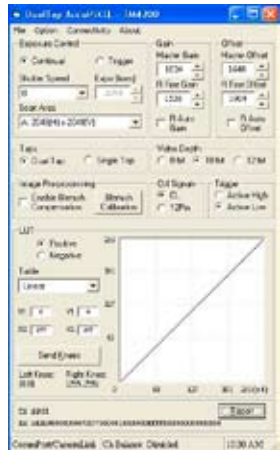

Camera parameters can be uploaded from the PC to the camera. Once these parameters are stored in EEPROMs, an instantaneous change from one setting to another can be done with a delay of few frames in between.

Software available for download at www.jai.com

Spectral Response

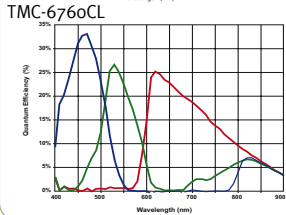
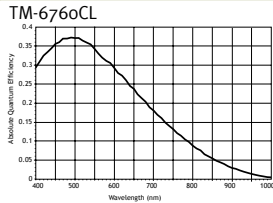

Connector Pin-out

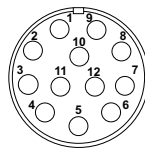

12-Pin Connector

1 GND	7 VD in
2 +12V DC	8 GND
3 GND	9 HD in
4 Video out	10 NC
5 GND	11 INTEG/ROI
6 NC	12 NC

Shutter Speed

	Manual	Async
0	no shutter (1/60)	no shutter (1/60)
1	1/125	1/32,000
2	1/250	1/16,000
3	1/500	1/8,000
4	1/1,000	1/4,000
5	1/2,000	1/2,000
6	1/4,000	1/1,000
7	1/8,000	1/500
8	1/16,000	1/250
9	1/32,000	Ext. pulse width control

Ordering Information

Camera	
Lead Processing	TM-6760CL (mono), TMC-6760CL (color)
RoHS Compliant	RM-6760CL (mono), RMC-6760CL (color)
Optional Functions	
Internal IR Filter Added	OP3-1
Optical Filter Removal	OP3-2
Glassless CCD Imager	OP21
Ultraviolet Imager	OP21-UV (monochrome only)
Strobe Output	OP8o
10-Bit Output	OP93-1
Optional Accessories (must be ordered separately)	
I/O	26CL-02-26
Power Supply	PD-12UUP series (includes power connector)
Power Cable	12P-02S

Dimensions

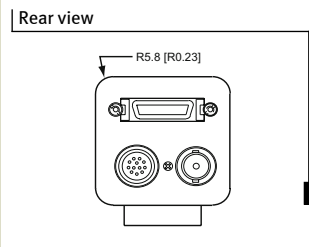
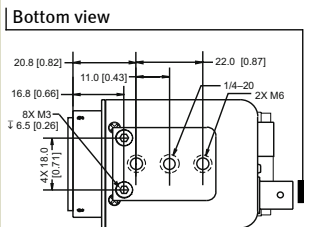
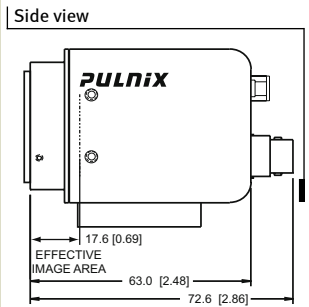
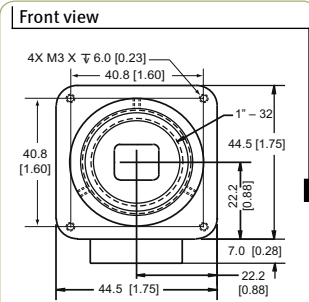

Europe, Middle East & Africa
Phone +45 4457 8888
Fax +45 4491 8880

Asia Pacific
Phone +81 45 440 0154
Fax +81 45 440 0166

Americas
Phone (Toll-Free) 1 800 445 5444
Phone +1 408 383 0300

See the possibilities



Visit our web site on www.jai.com